



SMD Quartz Crystal - HC-49S/SMD - 4 Pads

4 Pad Version - 13.0 x 4.73 x 5.0mm

• Features

- Low cost & wide applications
- Tight tolerance and Stability
- RoHS compliant

• General Specification

Type	HC-49S/SMD - 4 Pads
Frequency Range	3.20MHz to 90.00MHz
Frequency Tolerance at 25°C	± 30ppm *
Frequency Stability	± 50ppm *
Operating Temperature	-10°C to +60°C *
Load Capacitance	6pF to 32pF / Series
Shunt Capacitance	7pF max *
Storage Temperature	-40°C to +85°C *
Drive Level	100μW *
Aging	± 5ppm max first year *

* Can be changed according to Customer's requirement.

• Drive Level Codes (μW)

A = 100	B = 200	D = 50	E = 300	G = 500	I = 10
---------	---------	--------	---------	---------	--------

• Load Capacitance Codes

12pF = A	12.5pF = B	14pF = C	16pF = D	17pF = E	18pF = F
20pF = G	25pF = H	30pF = I	32pF = J	33pF = K	Series = L
13pF = M	27pF = N	50pF = O	10pF = P	15pF = Q	22pF = R
15.8pF = S	8.5pF = T	8.2pF = U	40pF = V	9pF = W	11pF = X
13.8pF = Y	19.6pF = Z	6pF = a	7pF = d	8pF = e	19pF = f

• Operating Temperature Codes (°C)

A = -10 to +60	B = -20 to +70	C = -10 to +70	I = -40 to +85	X = -30 to +80	W = -10 to +50
----------------	----------------	----------------	----------------	----------------	----------------

• Frequency Tolerance & Frequency Stability Codes (ppm)

P = ±10	S = ±20	T = ±30	U = ±50	V = ±100	W = ±5
---------	---------	---------	---------	----------	--------

Pls contact us for the parameters you could not find in these tables.

SMD Quartz Crystal - HC-49S/SMD - 4 Pads

• Frequency Stability vs. Operating Temperature

	± 10ppm	± 20ppm	± 30ppm	± 50ppm	± 100ppm
-10°C - +60°C	⊙	⊙	●	⊙	⊙
-10°C - +70°C	⊙	⊙	●	⊙	⊙
-20°C - +70°C	⊙	⊙	●	●	⊙
-40°C - +85°C			⊙	●	⊙

⊙ Available ● Standard

• ESR (Series Resistance Rs) vs Standard Frequency, Vibration Mode & Codes

Frequency Range (MHz)	ESR Max (Ω)	Code	Vibration Mode	Code
3.200 - 4.000	150	1	AT Fund	A
4.001 - 5.000	120	2	AT Fund	A
5.001 - 5.999	100	0	AT Fund	A
6.000 - 6.999	80	2	AT Fund	A
7.000 - 8.000	60	4	AT Fund	A
8.001 - 9.999	80	0	AT Fund	A
10.000 - 26.999	50	2	AT Fund	A
27.000 - 35.328	40	4	AT Fund	A
24.000 - 50.000	120	e	3rd OT	a3
50.001 - 90.000	80	0	3rd OT	a3

• Marking

Frequency + N (Company brand: Newxtal) + Date code (Year Code + Month Code)

Year Code:

2001	2002	2003	2004	2005	2006	2007	2008	2009	2010	2011	2012
1	2	3	4	5	6	7	8	9	10	11	12

Month Code:

Jan	Feb	March	April	May	June	July	Aug	Sept	Oct	Nov	Dec
A	B	C	D	E	F	G	H	I	J	K	L

For Example:

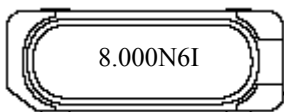

SMD Quartz Crystal - HC-49S/SMD - 4 Pads

Ordering Information

Drive Level	Load Capacitance	Operating Temperature	Frequency Tolerance	Frequency Stability	ESR	Type	Vibration Mode	Frequency	Lead-free	Packing
(μ W)	(pF)	($^{\circ}$ C)	(ppm)	(ppm)	(Ω)			(MHz)		
See Tables						J=HC49S/SMD, 4 pads	See Table	xx.xxxM	LF	TR
100	20	-20 to +70	± 20	± 30	50		AT Fund		Lead-free	Tape & reel
A	G	B	S	T	2	J	A		LF	TR

For Example: **AGBST2JA-18.400MLF/TR**

Dimensions

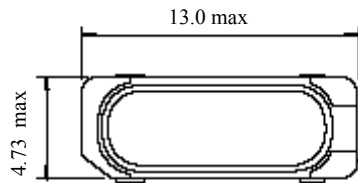

Top view

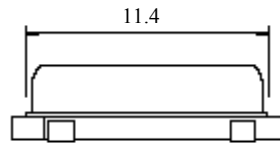

Side view

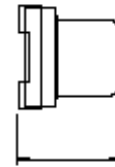

5.0±0.1

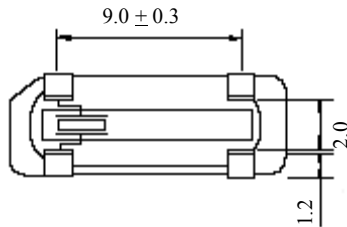

Bottom view

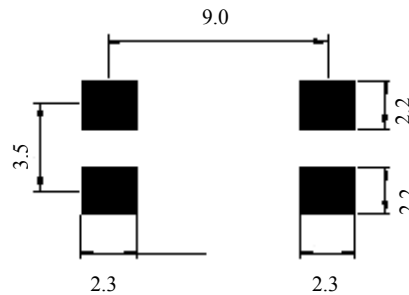

Solder Pad layout

in mm

SMD Quartz Crystal - HC-49S/SMD - 4 Pads

• Taping Specification

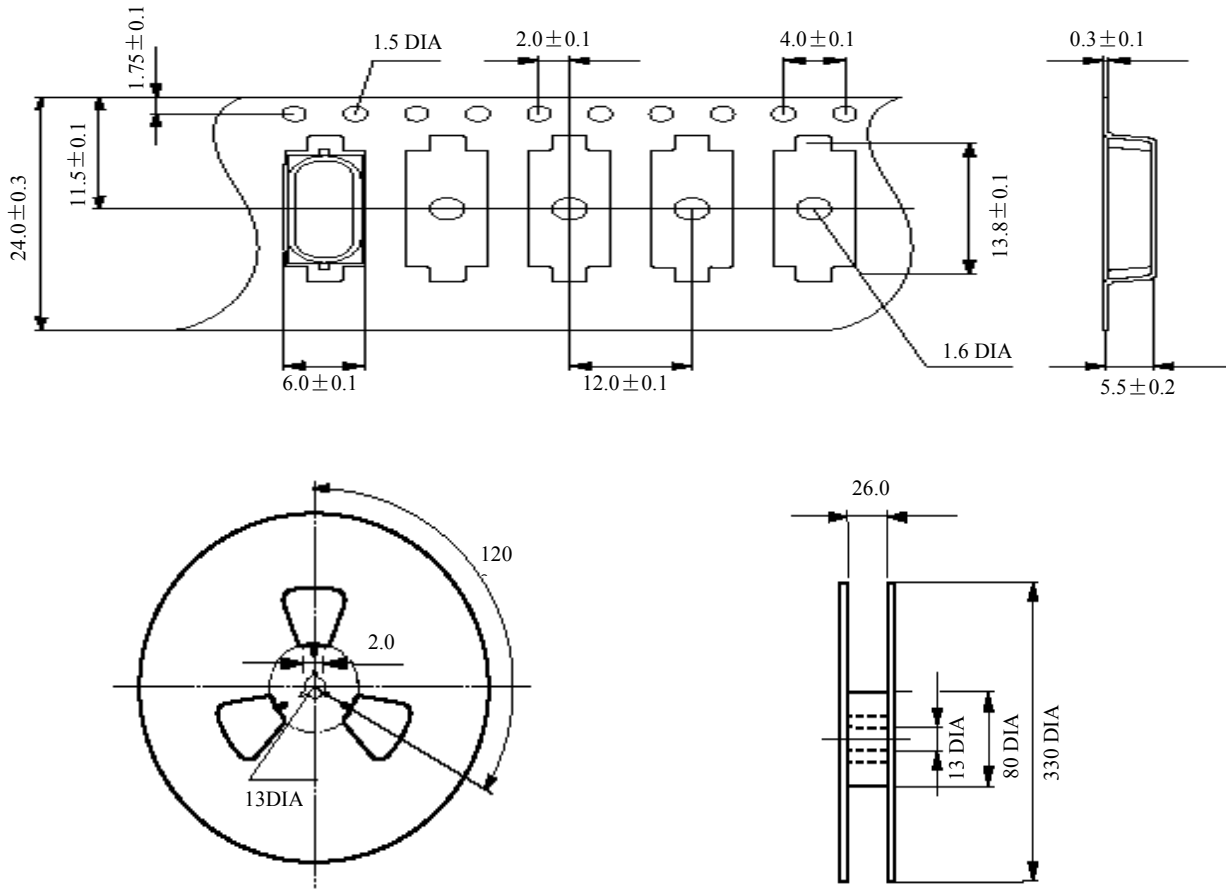

* Reel Quantity: 1,000pcs

in mm

• Reflow Soldering Profile

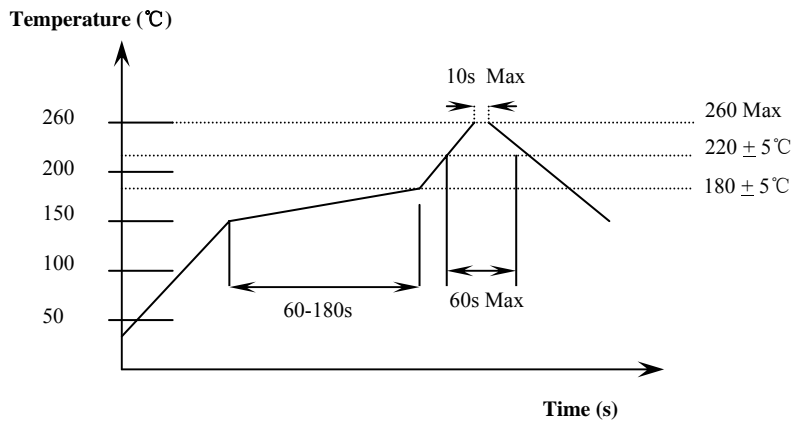

NEWXTAL - New Crystal World

Website: www.newxtal.com

Email: hkcrystal@incnets.com