



SMD Quartz Crystal - SMD 4025 - 4 Pads

4 Pad Version - 4.0 x 2.5 x 0.8mm

• Features

- Small size
- Tight tolerance and Stability
- RoHS compliant

• General Specification

Type	SMD 4.0 x 2.5 - 4 Pads
Frequency Range	15.000MHz to 40.000MHz
Frequency Tolerance at 25°C	± 30ppm *
Frequency Stability	± 30ppm *
Operating Temperature	-10°C to +60°C *
Load Capacitance	8pF to 32pF / Series
Shunt Capacitance	7pF max *
Storage Temperature	-40°C to +85°C *
Drive Level	100µW *
Aging	± 5ppm max first year *

* Can be changed according to Customer's requirement.

• Drive Level Codes (µW)

A = 100	B = 200	D = 50	E = 300	G = 500	I = 10
---------	---------	--------	---------	---------	--------

• Load Capacitance Codes

12pF = A	12.5pF = B	14pF = C	16pF = D	17pF = E	18pF = F
20pF = G	25pF = H	30pF = I	32pF = J	33pF = K	Series = L
13pF = M	27pF = N	50pF = O	10pF = P	15pF = Q	22pF = R
15.8pF = S	8.5pF = T	8.2pF = U	40pF = V	9pF = W	11pF = X
13.8pF = Y	19.6pF = Z	6pF = a	7pF = d	8pF = e	19pF = f

• Operating Temperature Codes(°C)

A = -10 to +60	B = -20 to +70	C = -10 to +70	I = -40 to +85	X = -30 to +80	W = -10 to +50
----------------	----------------	----------------	----------------	----------------	----------------

Pls contact us for the parameters you could not find in these tables.

SMD Quartz Crystal - SMD 4025 - 4 Pads

• Frequency Tolerance & Frequency Stability Codes (ppm)

P = ± 10	S = ± 20	T = ± 30	U = ± 50	V = ± 100	W = ± 5
----------	----------	----------	----------	-----------	---------

• Frequency Stability vs. Operating Temperature

	± 10ppm	± 20ppm	± 30ppm	± 50ppm	± 100ppm
-10°C- +60°C	⊙	⊙	●	⊙	⊙
-10°C- +70°C	⊙	⊙	●	⊙	⊙
-20°C- +70°C	⊙	⊙	●	●	⊙
-40°C- +85°C			⊙	●	⊙

⊙ Available ● Standard

• ESR (Series Resistance Rs) vs Standard Frequency, Vibration Mode & Codes

Frequency Range (MHz)	ESR Max (Ω)	Code	Vibration Mode	Code
15.000 - 19.999	80	0	AT Fund	A
20.000 - 29.999	60	1	AT Fund	A
30.000 - 40.000	40	4	AT Fund	A

• Marking

Frequency + M (MHz) + Date code (Year Code + Month Code)

NEWXTAL (Company Brand)

Year Code:

2001	2002	2003	2004	2005	2006	2007	2008	2009	2010	2011	2012
1	2	3	4	5	6	7	8	9	10	11	12

Month Code:

Jan	Feb.	Mar	April	May	June	July	Aug.	Sept	Oct	Nov	Dec
A	B	C	D	E	F	G	H	I	J	K	L

For Example:

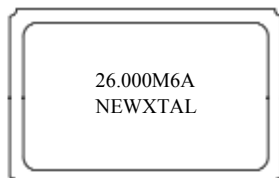

NEWXTAL - New Crystal World

Website: www.newxtal.com

Email: hkcrystal@incnets.com

SMD Quartz Crystal - SMD 4025 - 4 Pads

Ordering Information

SMD	Terminal	Size	Drive Level	Load Capacitance	Operating Temperature	Frequency Tolerance	Frequency Stability	ESR	Vibration Mode	Frequency	Lead-free	Packing	
			(μ W)	(pF)	($^{\circ}$ C)	(ppm)	(ppm)	(Ω)		(MHz)			
SMD Crystal	0=2 Pads 1=4 Pads	D=4.0x2.5	See Tables								xx.xxxM	LF	TR
			100	16	-10 to +60	± 10	± 10	60	AT Fund		Lead-free	Tape & reel	
S	1	D	A	D	A	P	P	1	A		LF	TR	

For Example: SIDADAPP1A-26.000MLF/TR

Dimensions

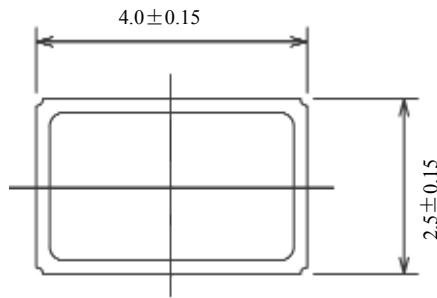

Top view

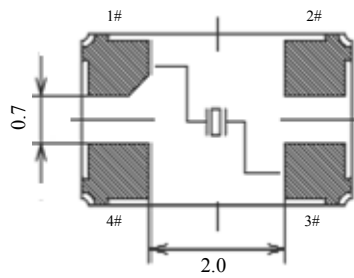

Bottom view

Pin Connection

- 1# Crystal
- 2# Connected with a cover
- 3# Crystal
- 4# Connected with a cover

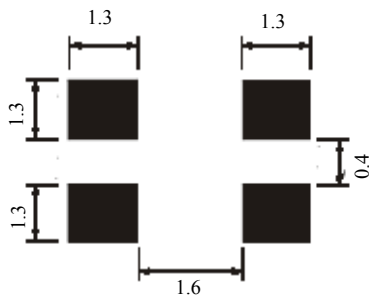

Pad layout

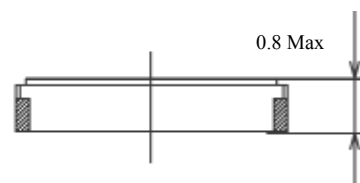

Side view

in mm

NEWXTAL - New Crystal World

Website: www.newxtal.com

Email: hkcrystal@incnets.com

SMD Quartz Crystal - SMD 4025 - 4 Pads

• Taping Specification

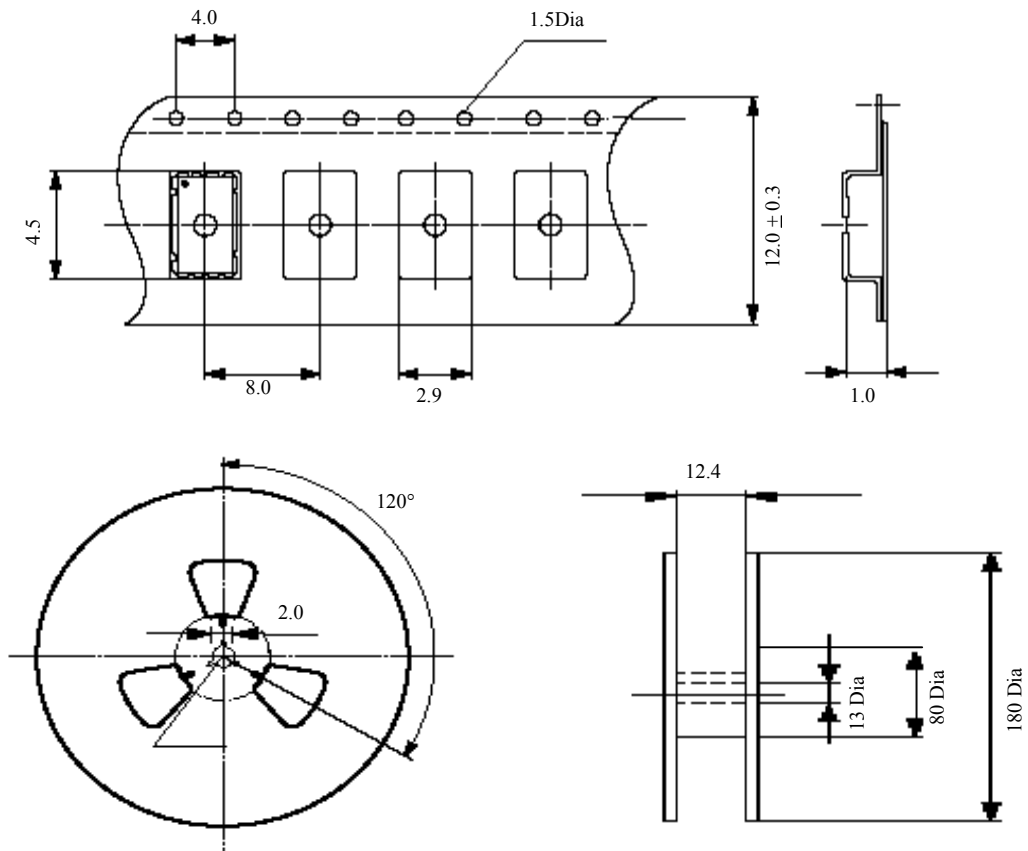

* Reel Quantity: 1,000pcs

in mm

• Reflow Soldering Profile

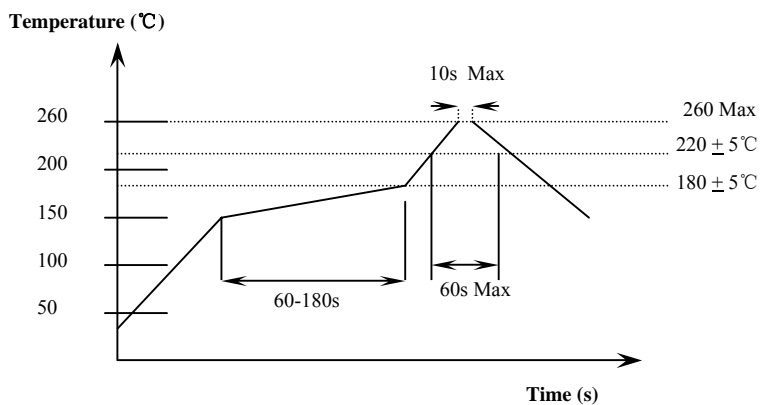

NEWXTAL - New Crystal World

Website: www.newxtal.com

Email: hkcrystal@incnets.com